

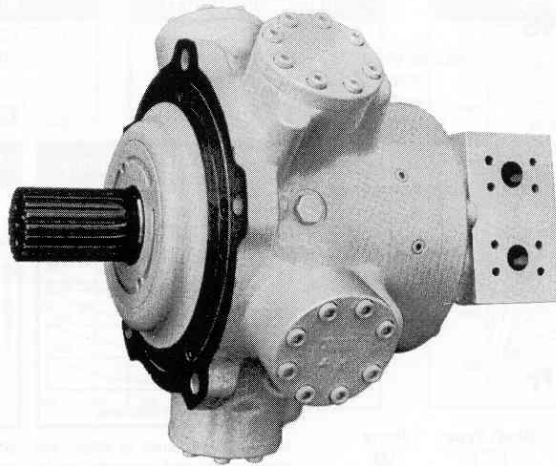

MRH-45 MRH 2-45

Low Speed—High Torque
SINGLE AND MULTIPLE

DISPLACEMENT HYDRAULIC MOTORS



KYB®

America LLC

140 N. Mitchell Court • Addison, Illinois 60101 USA • Phone: 630-620-5555 • Fax: 630-620-8133
e-mail: hyd@kyb.com • <http://www.kyb.com>

MRH-45 Single Displacement Motor by Hydrostar®

MRH-45 Performance Curve

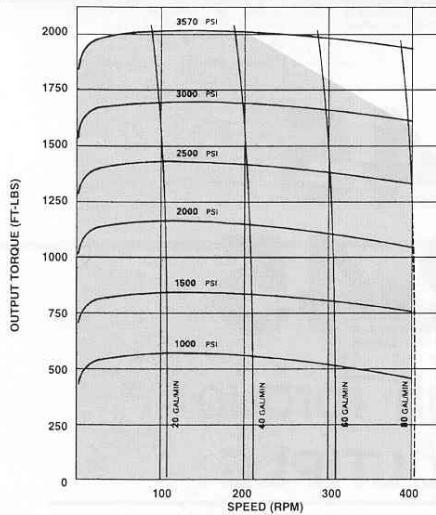

SPECIFICATIONS

Displacement	45.5 IN. ³ /REV.
Maximum continuous pressure	3570 PSI
Intermittent peak pressure	4000 PSI
Maximum continuous back pressure	350 PSI
Maximum intermittent back pressure	1000 PSI
Maximum continuous output torque	2040 FT.-LBS.
Starting torque at 3570 PSI	1720 FT.-LBS.
Maximum continuous speed	400 RPM
Maximum continuous power	120 HP
Moment of Inertia (GD ²)	325 LB.-IN. ²
Maximum fluid temperature	175° F
Dry weight	275 LBS.

HOW TO ORDER

Model	Displacement	Shaft Type	Ports
MRH	45	<input type="checkbox"/>	W
		S — Spline (20T)	SAE
		E — Spline (17T)	4-Bolt Flange
		T — Taper	

Graph 1

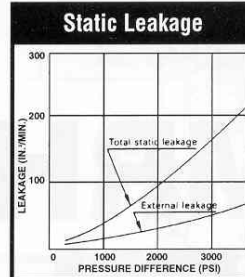

Total static leakage is: internal leakage & external leakage. Total static leakage is used when the outlet port is blocked and the torque load attempts to rotate the shaft as in winch applications. Values given will be considerably greater unless sufficient inlet pressure is maintained. The creep speed can be calculated from the following formula:

$$\text{Creep Speed (RPM)} = \frac{\text{Total Static Leakage (IN.³/MIN.)}}{45.5 \text{ (IN.³/REV.)}}$$

Graph 2

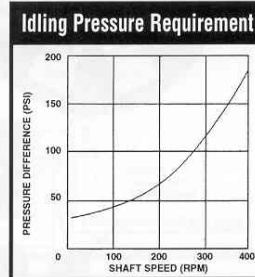

Graph 2 indicates pressure difference required to idle the motor at various speeds and no output torque. Values will be slightly greater at higher viscosities. Caution should be taken to assure sufficient inlet pressure is maintained to prevent cavitation when the motor operates as a pump or when the load overruns the motor. Sufficient back pressure should be maintained to counteract centrifugal forces in the motor. Back or boost pressure is the pressure present at the low pressure port of the motor. These minimum pressures can be calculated as follows:

$$\text{Boost or Back Pressure (PSI)} = \frac{1}{2} \text{ Idling Pressure (PSI)} + \text{Crankcase Pressure (PSI)}$$

Graph 3

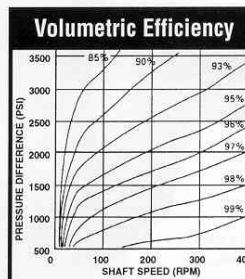

Input flow required to attain any given speed and pressure can be calculated from the graph using the nominal motor displacement of 45.5 in.³/REV.

$$\text{Input Flow (IN.³/MIN.)} = \frac{45.5 \text{ (IN.³/REV.)} \times \text{Motor Speed (RPM)} \times 100}{\text{Motor Volumetric Efficiency (\%)}}$$

$$1 \text{ GAL./MIN.} = 231 \text{ IN.³/MIN.}$$

Graph 4

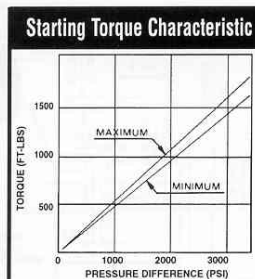

Starting torque varies with the crankshaft angle and maximum and minimum values are shown by the graph. A reduction in torque occurs if back pressure is excessive but viscosity effects are negligible.

Above curves are results obtained on mineral oil of 160-200 SUS viscosity.

Oil and Filtration

Because the oil not only transfers the force but also lubricates mating parts of the motor, care must be taken to assure minimum fluid viscosity is 120 SUS. However, it is recommended for continuous operation to maintain the viscosity between 165 and 345. Maximum operating temperature should be less than 175°F.

However, even when the proper oil is used, wear will accelerate as oil becomes contaminated. Hydraulic fluid life depends on conditions under which it is used and only experience can determine precise intervals at which fluids should be changed. With mineral oils it is recommended that samples be taken at about 1000 hour intervals and sent to the manufacturer for analysis. This will help determine the best timing for fluid changes.

Filtration recommendation is 25 micron. Since pumps are more critical to contamination, it is advisable to investigate what filtration will be required to sustain the life of the pump.

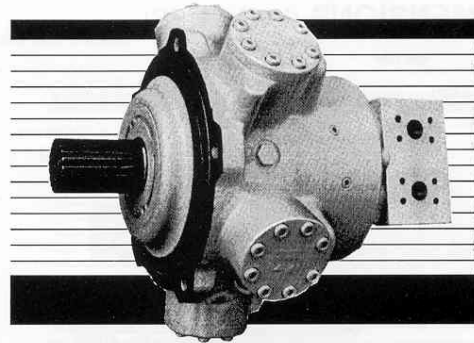

Minimum Operating Speed

Minimum operating speed of 1 rpm is possible depending on load characteristics, but smooth performance of 3 rpm is normal. Starting torque varies with crankshaft angle. A reduction in torque occurs if the back pressure is excessive, but viscosity effects are negligible.

Bearing B10-LIFE

Bearing B10-LIFE of taper roller bearings used in HYDROSTAR® motors is explained in Graph 5 below. Bearing B10-LIFE is the number of hours at which 10% of the bearings may be expected to show some evidence of wear. The other 90% will be satisfactory. In fact, the average life of the bearings is 4 times the B10-LIFE.

Graph 5

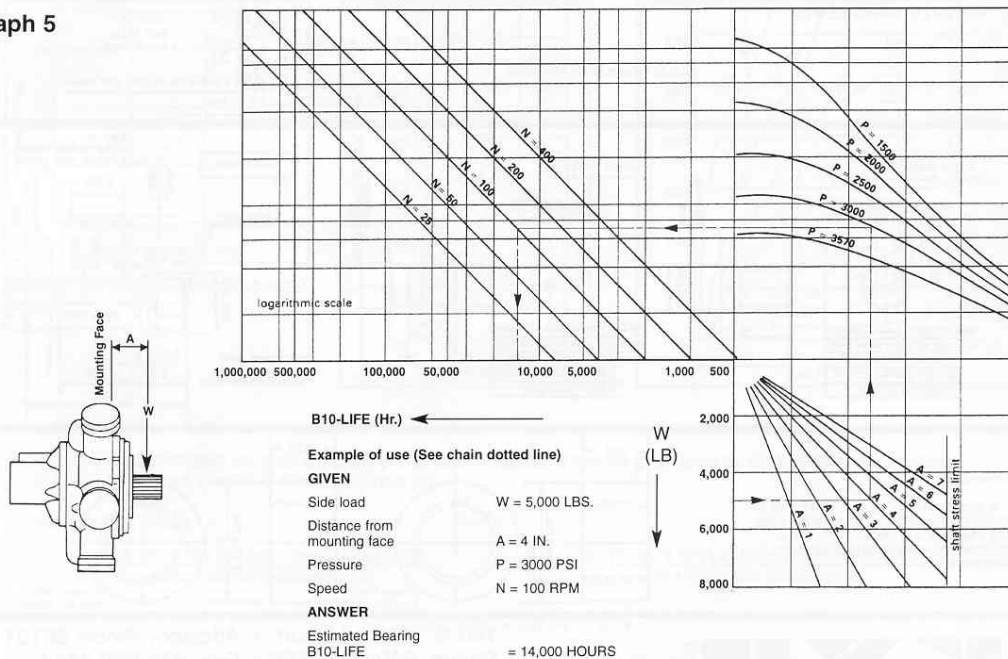

MRH 2-45 Multiple Speed Hydraulic Motor

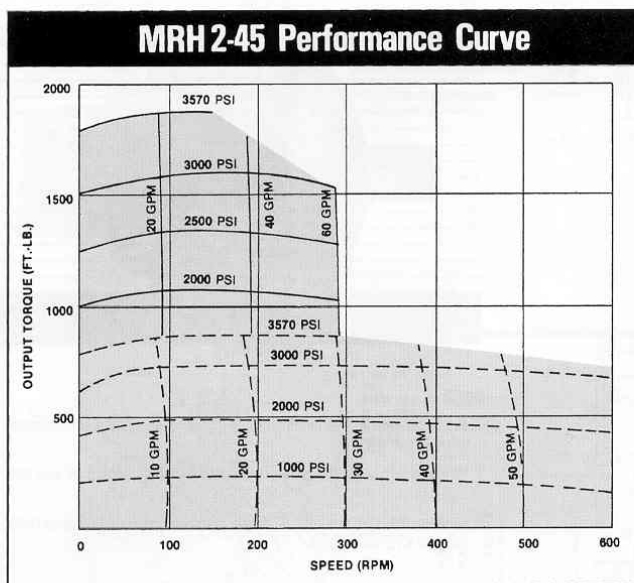

Graph 6

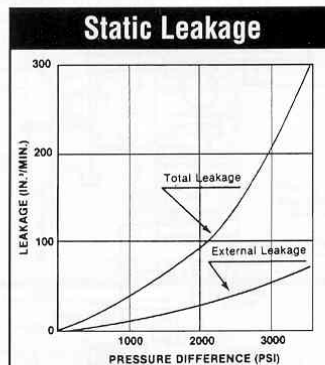

Total static leakage is the combination of internal leakage and external leakage. Total static leakage is used when the outlet port is blocked and the torque load attempts to rotate the shaft, such as a winch application. Unless significant back pressure is maintained, the creep speed will increase drastically and the motor may rotate out of control. The creep speed can be calculated from the following formula:

$$\text{Creep Speed (RPM)} = \frac{\text{Total Static Leakage (IN.}^3\text{/MIN.)}}{45.5 \text{ or } 22.75 \text{ (IN.}^3\text{/REV.)}}$$

SPECIFICATIONS

SPECIFICATIONS	MODEL	
	MRH 2-45-1	MRH 2-45-2
Displacement (In. ³ /Rev.)	45.5/22.75	45.5/0
Max. Continuous Pressure (PSI)	3570	3570/150
Intermittent Peak Pressure (PSI)	4000	4000/250
Max. Continuous Back Pressure (PSI)	350	350/—
Max. Intermittent Back Pressure (PSI)	1000	1000/—
Output Torque	@ 3000 PSI (Ft. Lbs.)	1630/745
	@ 3570 PSI (Ft. Lbs.)	1930/880
Max. Speed	@ 3000 PSI (RPM)	400/600
	@ 3570 PSI (RPM)	200/300
	Free Wheeling (RPM)	— / 2000
Max. Continuous Power (HP)	120	
Max. Fluid Temperature (°F)	175	
Dry Weight (Lbs.)	291	

For other displacement combinations consult KYB America LLC.

Graph 7

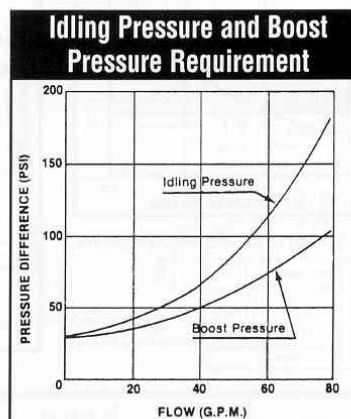

The idling pressure curve in Graph 7 indicates the pressure difference between ports to rotate the motor without a load. The boost pressure curve indicates the required pressure to prevent cavitation when the motor is driven by an external load, working as a pump.

Back or boost pressure should be maintained at all times when the shaft of the motor is rotating.

$$\text{Boost or Back Pressure (PSI)} = 1/2 \text{ Idling Pressure (PSI)} + \text{Crankcase Pressure (PSI)}$$

How To Order

Model	No. of Speeds	Displacement	Shaft Type	Ports
MRH	2	— 45 — □	S	W
	2 speed	See specification chart for displacement designation	Spline (20T)	SAE 4-Bolt Flange

TYPICAL CIRCUIT

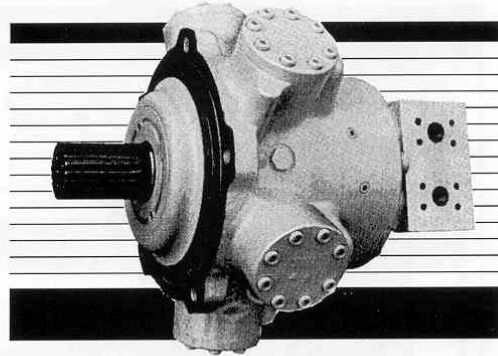
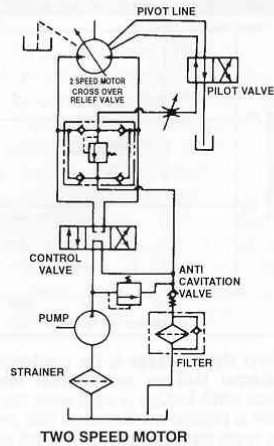

NOTE:

1. Pilot pressure should be equal to or greater than system pressure and at least 150 psi.
2. When freewheeling the pressure above the pistons should be less than 200 psi.
3. Cooling may be required if motor is freewheeled for long periods. Consult KYB America LLC.

Graph 8

Torque Requirement When Free Wheeling

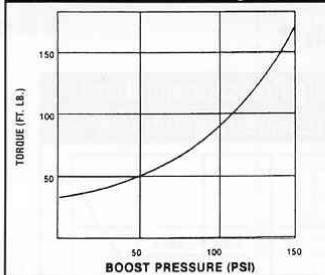

Minimum Input torque requirement when free wheeling.

Graph 9

Volumetric Efficiency (Full Displacement)

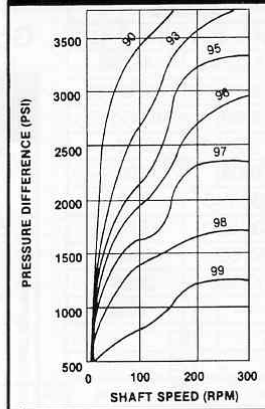

Graph 10

Volumetric Efficiency (Half Displacement)

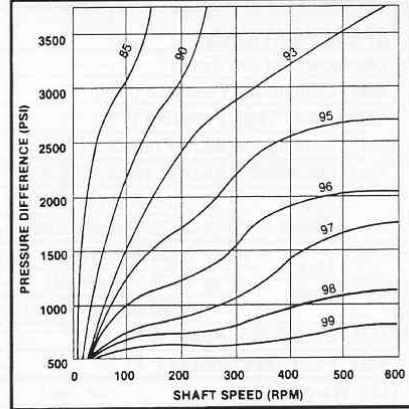

Input flow required to attain any given speed and pressure can be calculated from the graph using the nominal motor displacement of 45.5 IN.³/REV. (Graph 9) or 22.75 IN.³/REV. (Graph 10).

Inut Flow (IN.³/MIN.) =

$$\frac{45.5 (\text{IN.}^3/\text{REV.}) \times \text{Motor Speed (RPM)} \times 100}{\text{Motor Volumetric Efficiency (\%)}} \quad \text{OR} \quad \frac{22.75 (\text{IN.}^3/\text{REV.}) \times \text{Motor Speed (RPM)} \times 100}{\text{Motor Volumetric Efficiency (\%)}}$$

$$1 \text{ GAL./MIN.} = 231 \text{ IN.}^3 / \text{MIN.}$$

Above curves are results obtained on mineral oil of 160-200 SUS viscosity.

DIMENSIONS (IN INCHES)

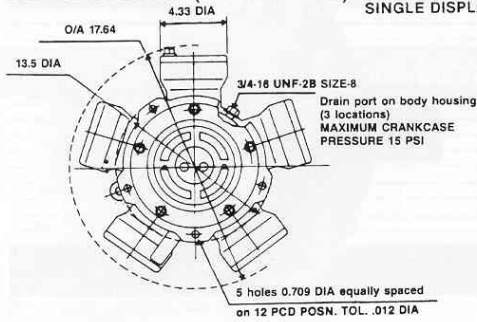

SINGLE DISPLACEMENT

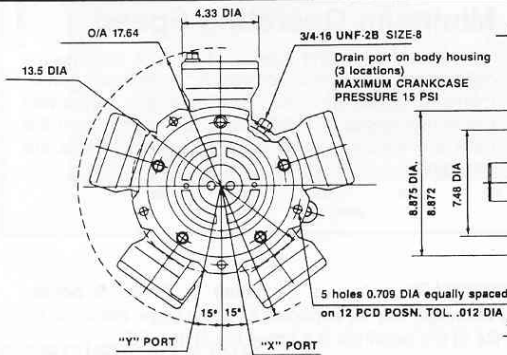
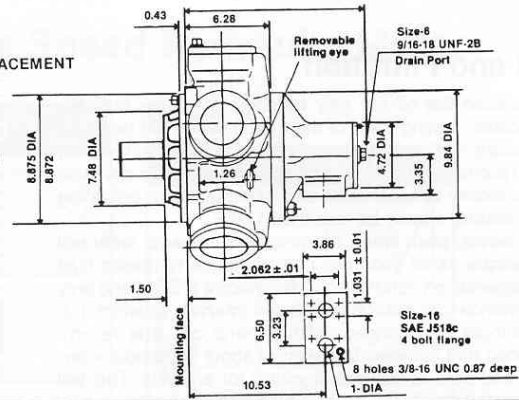

MULTIPLE DISPLACEMENT

NOTE: S-type shaft standard

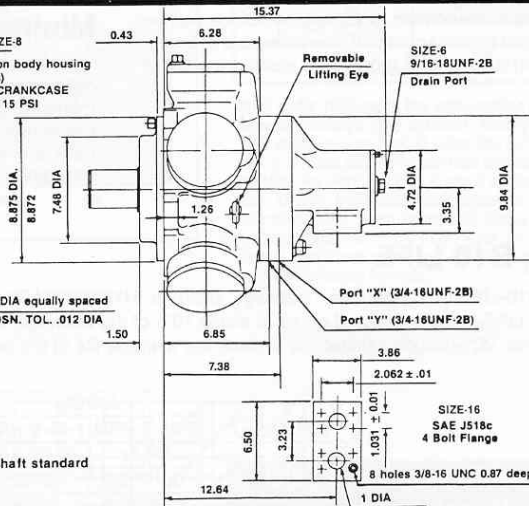

S-type shaft

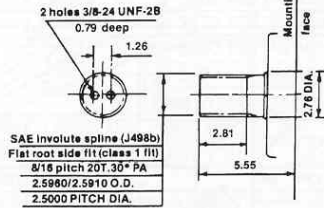

E-type shaft

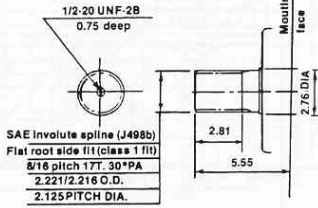

T-type shaft

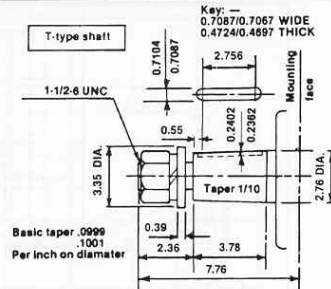

Spline adapter billets

A steel billet having internal splines to match the motor spline shaft is available. The shaft fits into the billet, which is intended for welding onto drive gears, sprockets, etc.

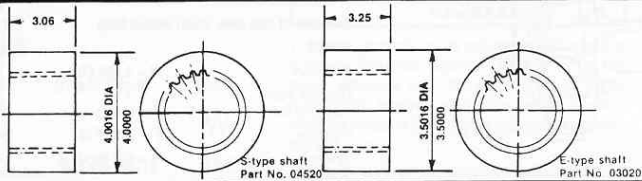

KYB America LLC

140 N. Mitchell Court • Addison, Illinois 60101
Phone: 630-620-5555 • Fax: 630-620-8133
e-mail: hyd@kyb.com • http://www.kyb.com